1.1	4
1.2	5
1.3	5
1.4	8
1.5	8
2.1	13
3.1	15
4.1	17
4.2	18
4.3	22
4.4	24
4.5	26
4.6	EMC	27
4.7	30
5.1	33
5.2	34
5.3	37
5.4	37
P0	39
P1	44
P2	46
P3	47

P4	V/F	48
P5		50
P6		54
P7		56
P8		59
P9	PID	63
PA	PLC	65
Pb		68
PC		71
Pd		73
PE		73
7.1		74
7.2		76
8.1		77
8.2		77
8.3		77
9.1		78
9.2		78
9.3		78
9.4		78
9.5		78
9.6			



告





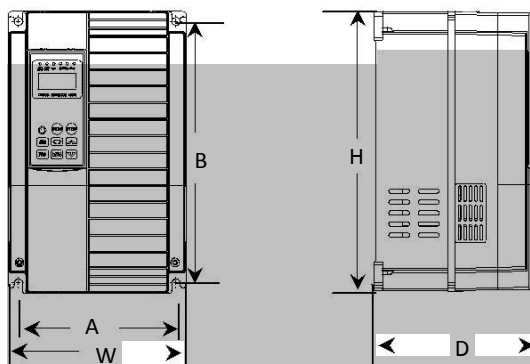
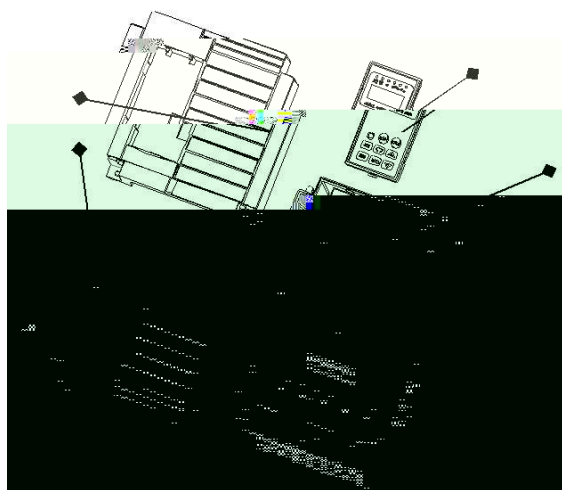

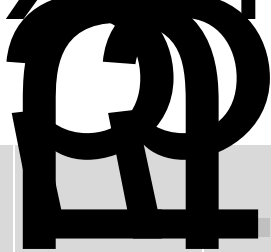

5

BGR/APS-

E303

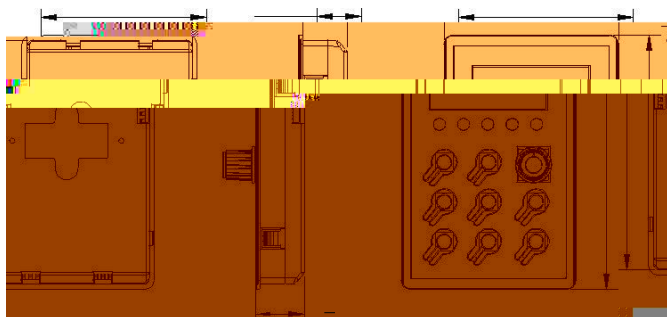

1-4 作 及

E304

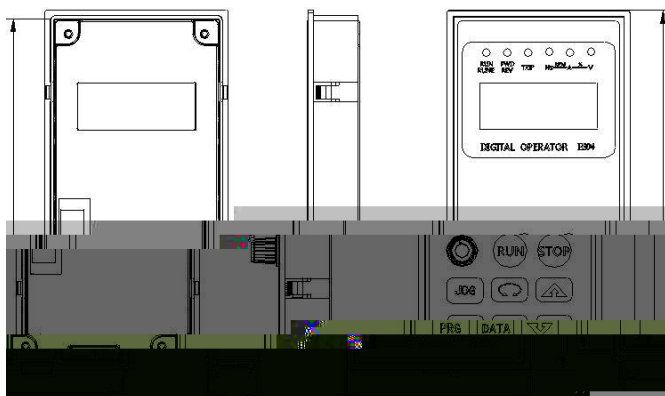

1-5 作 及





告



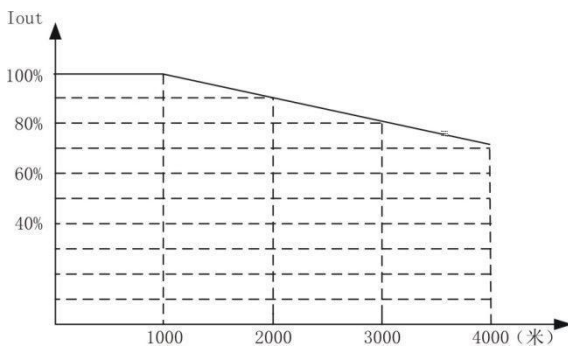



告



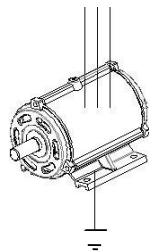
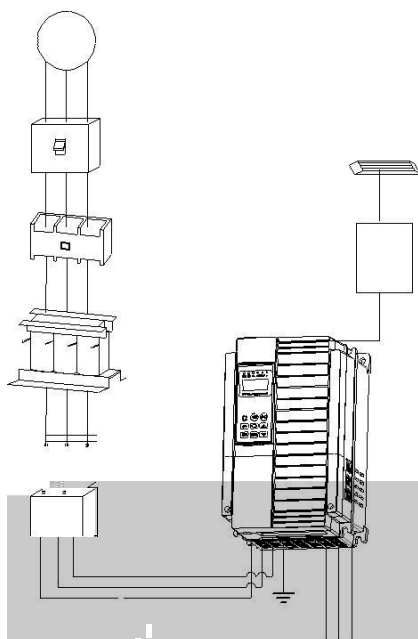

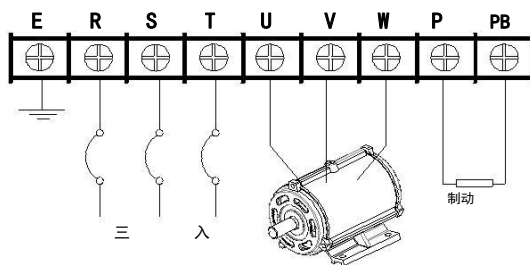
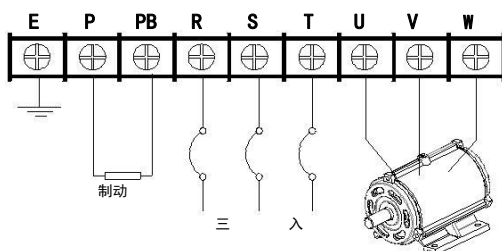
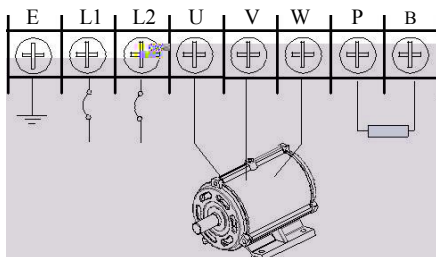

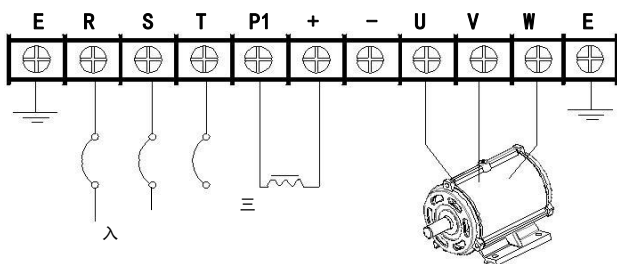
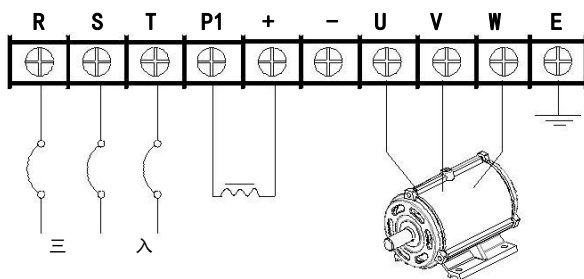
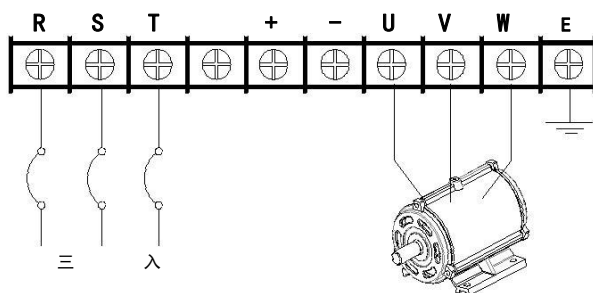

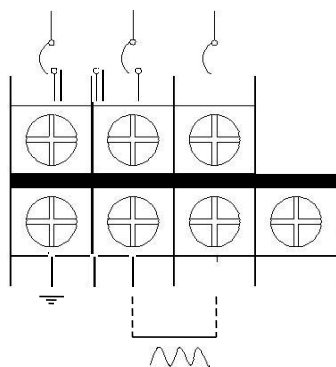
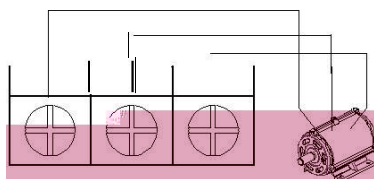
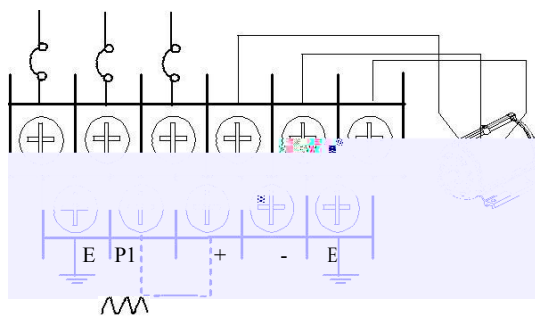



E  	
R S T	
L1 L2	
U V W	380V 220V
P1	+
+	1 P1 2 -
-	+
PB B	P +

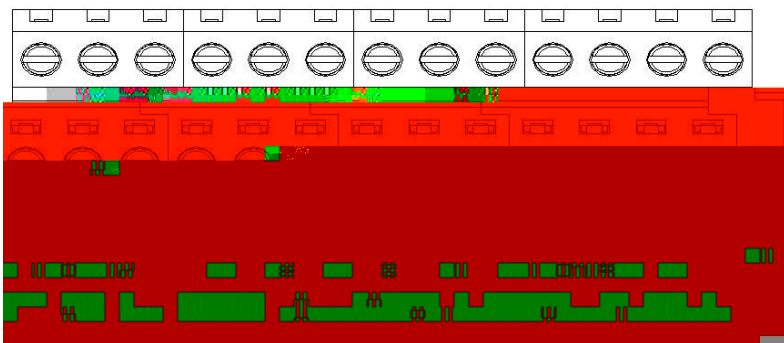

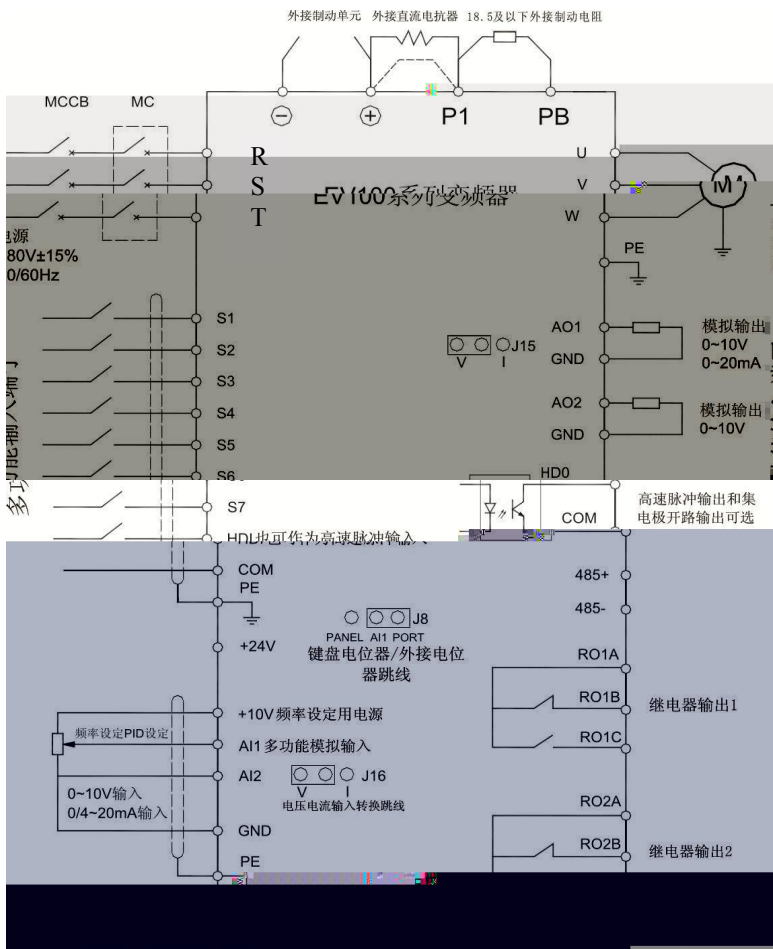

	~
	~ ~
	~
	~ ~
	~
	~ ~

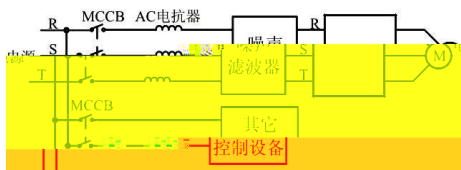

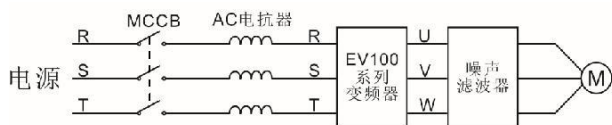

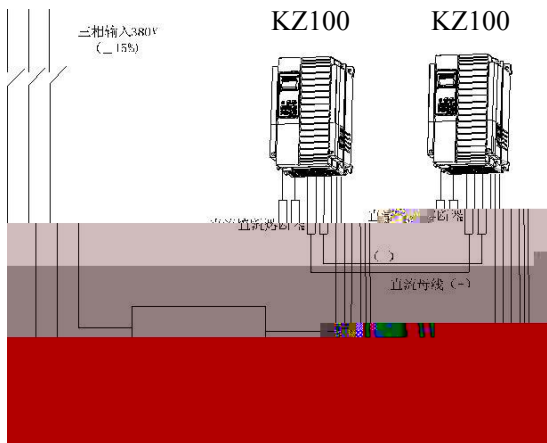









KZ100-0004G-S2			
KZ100-0007G-S2			
KZ100-0015G-S2			
KZ100-0022G-S2			
KZ100-0037G-T2			
KZ100-0055G-T2			
KZ100-0075G-T2			
KZ100-0110G-T2			
KZ100-0150G-T2			
KZ100-0185G-T2			
KZ100-0220G-T2			
KZ100-0300G-T2			
KZ100-0370G-T2			
KZ100-0450G-T2			
KZ100-0550G-T2			
KZ100-0007G-T4			
KZ100-0015G-T4			
KZ100-0022G-T4			
KZ100-0040G/0055P-T4			
KZ100-0055G/0075P-T4			
KZ100-0075G/0110P-T4			
KZ100-0110G/0150P-T4			
KZ100-0150G/0185P-T4			
KZ100-0185G/0220P-T4			

KZ100-0220G/0300P-T4			
KZ100-0300G/0370P-T4			
KZ100-0370G/0450P-T4			
KZ100-0450G/0550P-T4			
KZ100-0550G/0750P-T4			
KZ100-0750G/0900P-T4			
KZ100-0900G/1100P-T4			
KZ100-1100G/1320P-T4			
KZ100-1320G/1600P-T4			
KZ100-1600G/1850P-T4			
KZ100-1850G/2000P-T4			
KZ100-2000G/2200P-T4			
KZ100-2200G/2500P-T4			
KZ100-2500G/2800P-T4			
KZ100-2800G/3150P-T4			
KZ100-3150G/3500P-T4			
KZ100-3500G-T4			
KZ100-4000G-T4			
KZ100-5000G-T4			
KZ100-5600G-T4			
KZ100-6300G-T4			

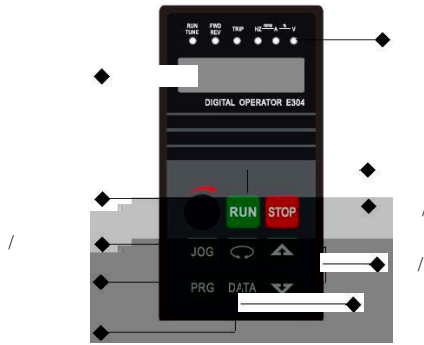
KZ100-0370G/0450P-T4						
KZ100-0450G/0550P-T4						
KZ100-0550G/0750P-T4						
KZ100-0750G/0900P-T4						
KZ100-0900G/1100P-T4						
KZ100-1100G/1320P-T4						
KZ100-1320G/1600P-T4						
KZ100-1600G/1850P-T4						
KZ100-1850G/2000P-T4						
KZ100-2000G/2200P-T4						
KZ100-2200G/2500P-T4						
KZ100-2500G/2800P-T4						
KZ100-2800G/3150P-T4						







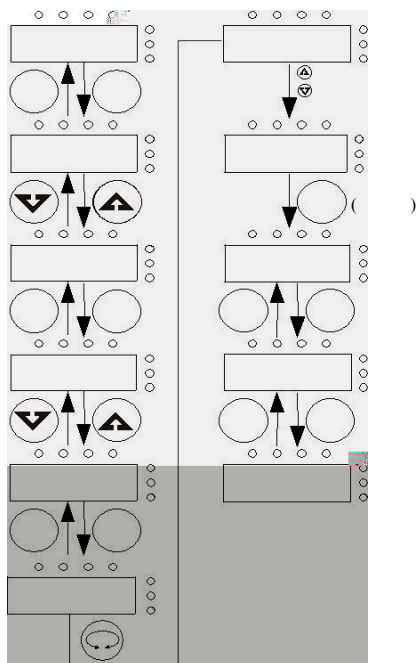





		~



		~

▲ ▼

		~



：  和  及

功 ， 停
动 。

		~

		~

		~

		~

		~

		~
		~

		~

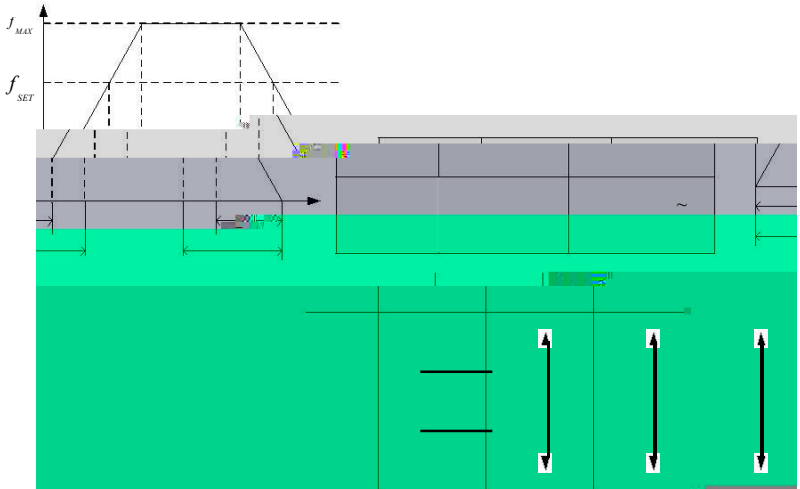

~			
~			
~			

		~

		~

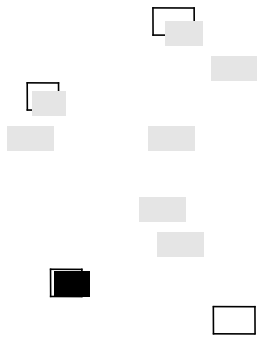

		~

		~

		~

		~

		~
		~

		~
		~
		~
		~

		~
		~



6-3

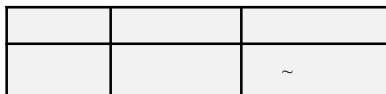
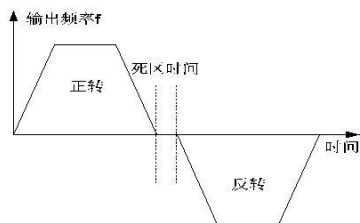
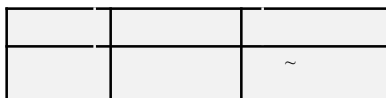

KZ100

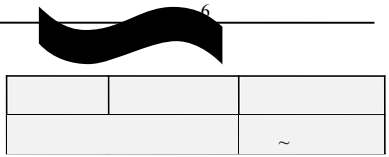
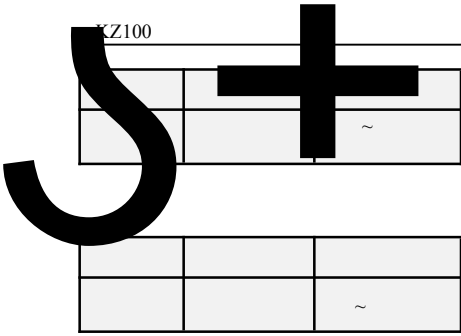

		~
		~

		~
		~
		~
		~
		~

		~

		~
		~

		~

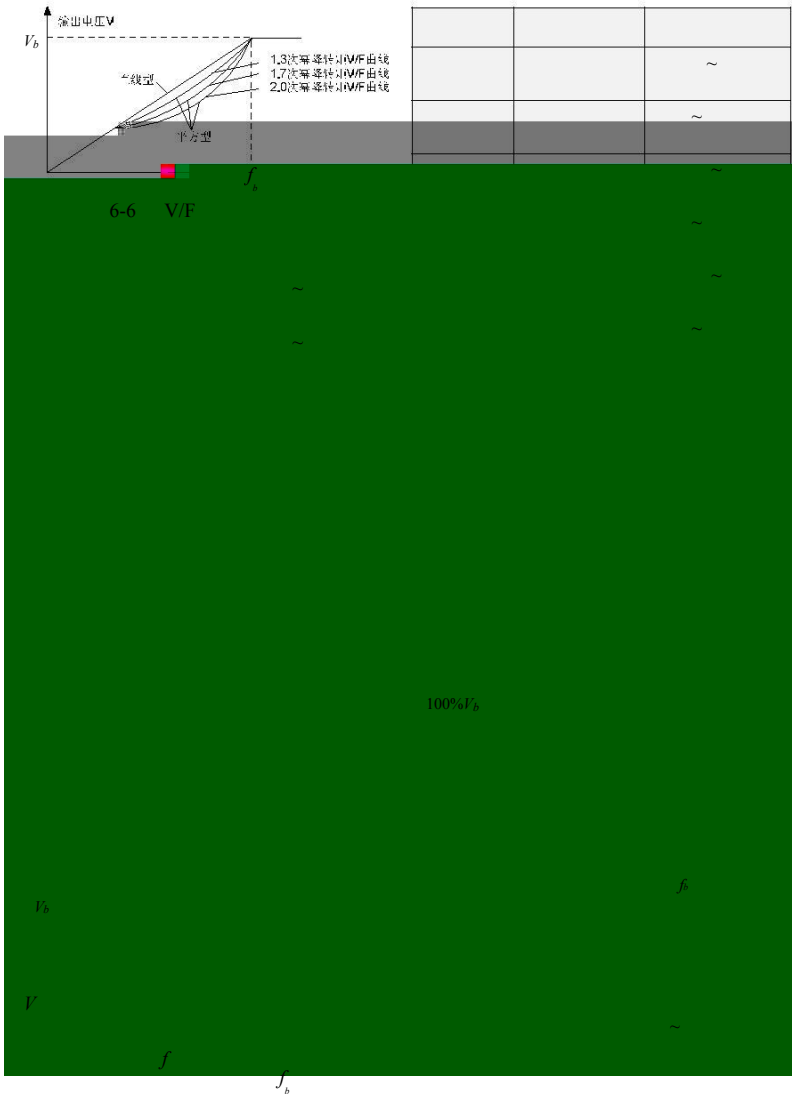





		~







		~

		~
		~
		~

		~
		~
		~
		~
		~
		~
		~
		~

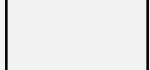
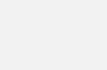

			
			
			
			



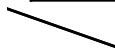

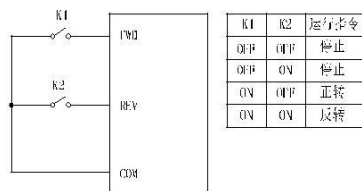
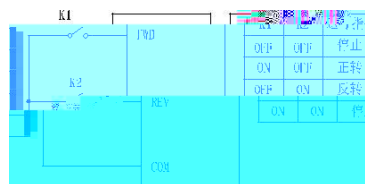

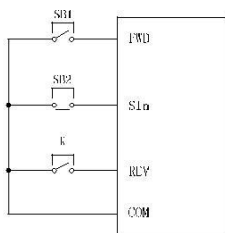
K	运行方向
SB2	停止
SB1	正转

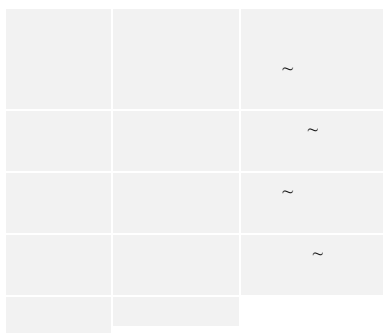
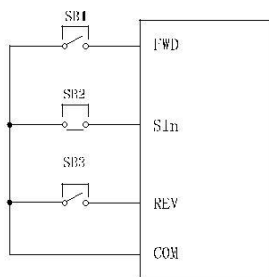
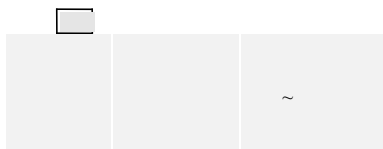

		~
		~
		~
		~

		~
		~
		~
		~
		~

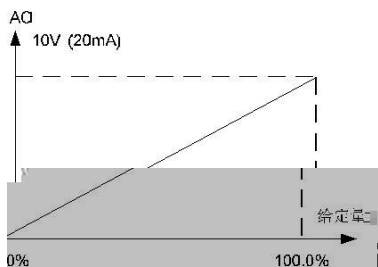
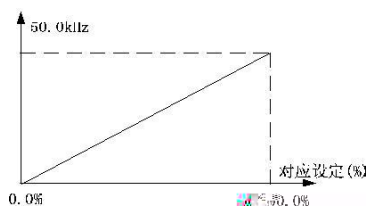

		~

		~
		~
		~
		~

		~



		~

		~

		~

		~
		~
		~
		~

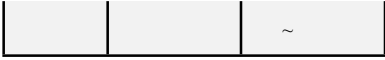

		~
		~
		~

		~
		~
		~
		~
		~
		~

		~
		~
		~

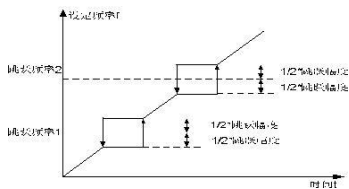
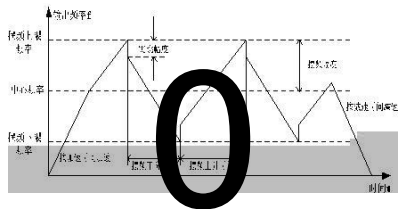
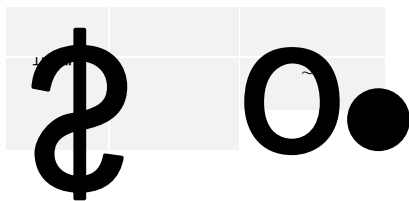

		~

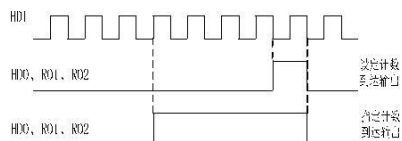

-		
		~
		~

		~

		~

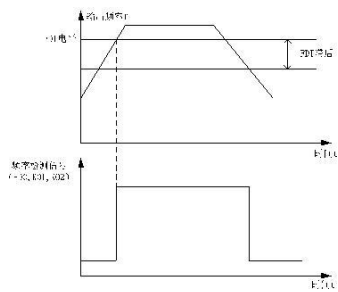

		~

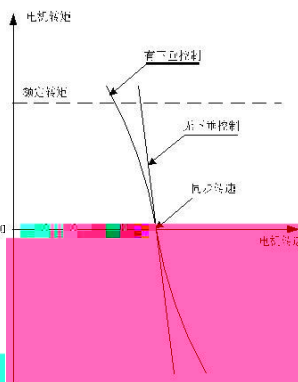
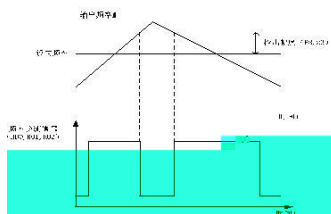

6-21

		~

		~

		~

		~

		~

		~

		~

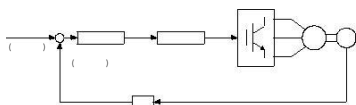

6-22 PID

		~

		~

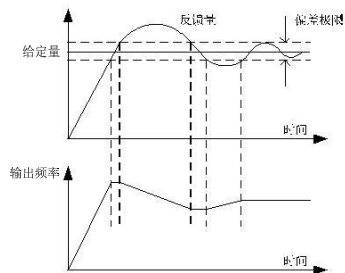

		~
		~

		~
		~

		~
		~
		~
		~
		~
		~
		~

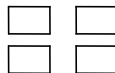
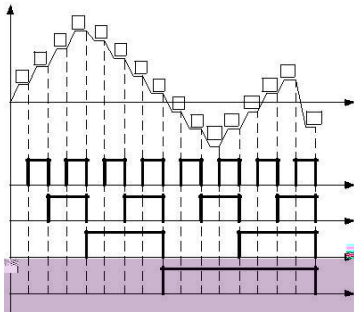

--	--	--

	~	~0x

		~

		~

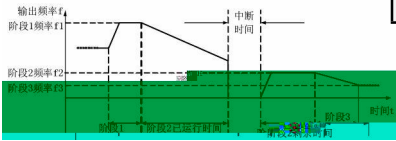

		~
		~

		~

		~
		~

		~

		~

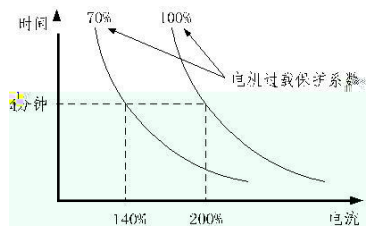

		~
		~

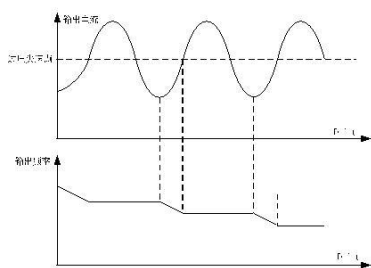

		~

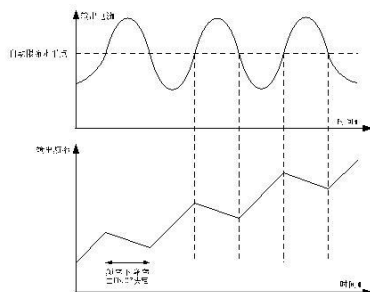

6-29

		~
		~

		~

	~	

		~

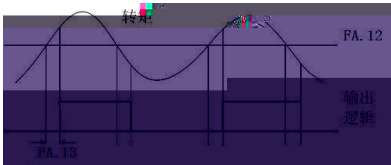

		~

		~

		~

		~

		~

~ Pd.09		

		~





告

~







~

~





			~			
			~			
			~			
		~	~			
		~	~			
		~	~			
		~	~			
			~			
			~			

		~	~			
			~			
		~	~			
		~	~5			
			~			
			~			
		~	~			
		~	~			

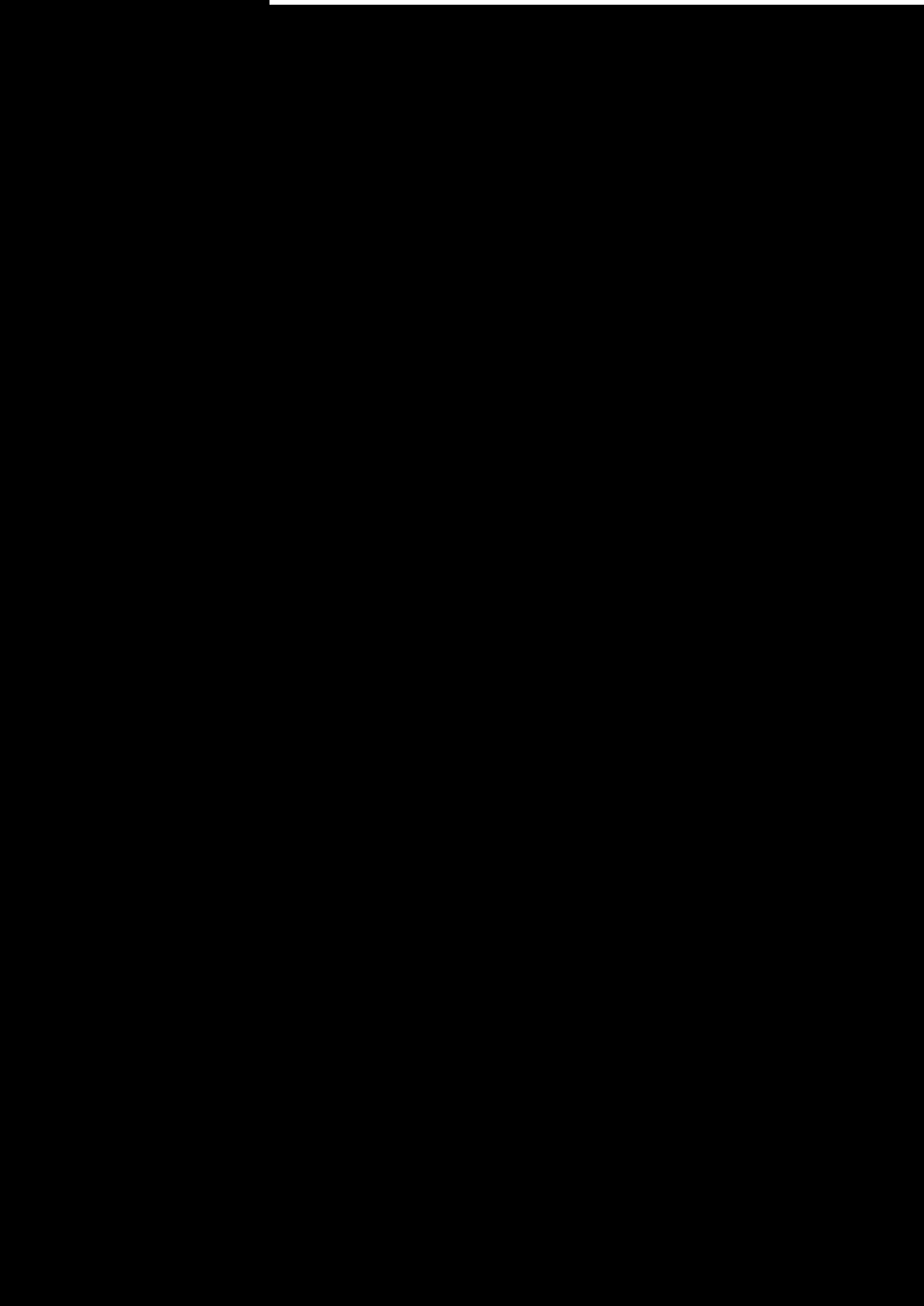
			~			
			~			
			~			
		~	~			
			~			
		~	~			
		~	~			
		~	~			
		~	~			
		~	~			
		~	~			



			~			
			~			
			~			
		~				

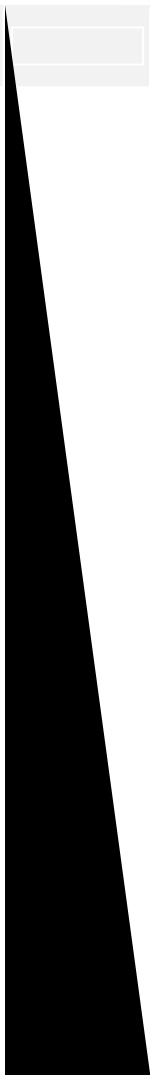

|--|--|--|--|--|--|--|

--	--	--	--	--	--	--

		~	~			
		~	~			
		~	~			
			~			
		~				
		~	~			
			~			
		~				
			~			
		~	~			
			~			
		~	~			
			~			

		~		~		
				~		
				~		
		~		~		
			~	~		
				~		
				~		

1 参

2

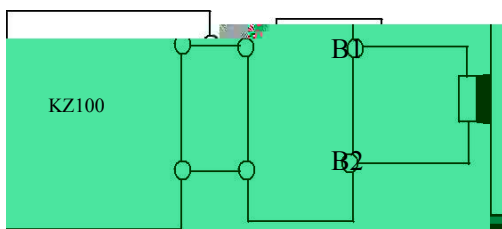
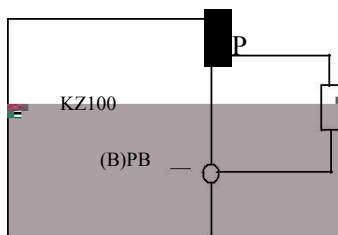

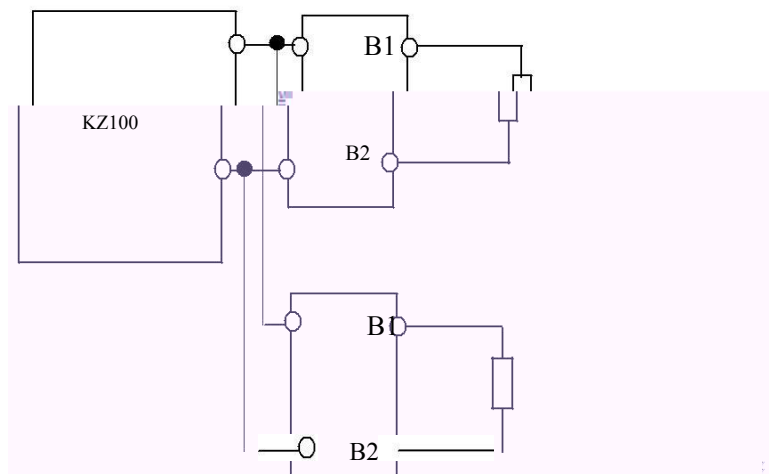

一、

二、关于产 与保修

三、厂 产产 保 内（ 合同协 ， 合同协 内 ）

、厂 保 利和免 任事